



FOUNDATION SOLUTIONS

PERMANENT CRAWL SPACE FORMWORK



MODULO



NEW ELEVATOR



BIOMODULO



DEFENDER

✓ **FAST**

✓ **LIGHT**

✓ **MODULAR**

INDEX



MODULO

Permanent crawl space formwork.

P. 5



NEW ELEVATOR

Permanent crawl space formwork, up to 3 m.

P. 19



BIOMODULO

Permanent formwork for air diffusion in composting plants and deodorization systems.

P. 30



DEFENDER

Modular panel for the protection of basement walls.

P. 36



DESIGN & ASSISTANCE

FROM PREDIMENSIONING TO FINAL DRAWING

Geoplast Technical Unit is at the disposal of architects and engineers to offer the required assistance during the implementation of a project. From the statistical calculations to the working drawings.

FEASIBILITY ANALYSIS

Technical Analysis of the project which includes the choice of the most suitable Geoplast's solution, material and manpower estimates and cost analysis.

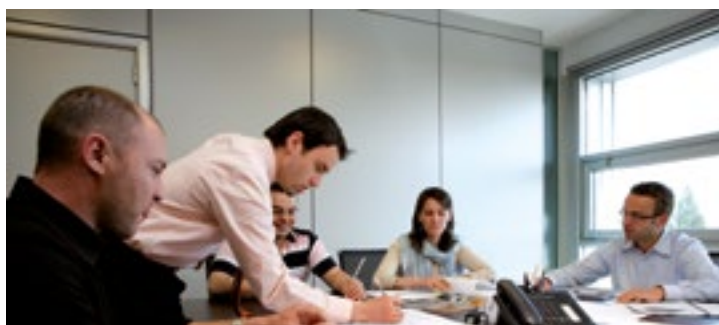

TECHNICAL ANALYSIS

Structural Analysis and writing of all the documentation that tests the performance of the proposed systems.

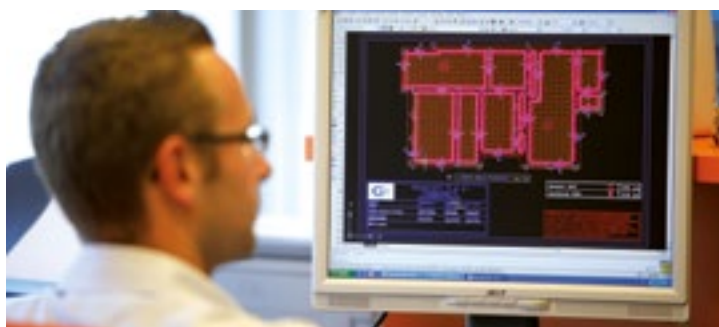

EXECUTIVE DESIGN

Support by design professionals. The in-depth analysis together with the formwork positioning plan and the related accessories can be supplied on request.

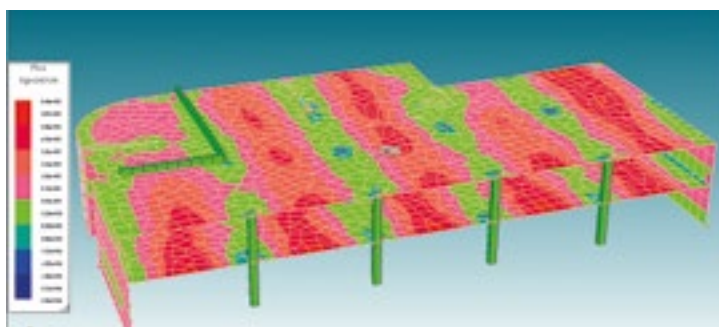

ON-SITE ASSISTANCE

When necessary, Geoplast's technical unit can be present on-site and help the company during the installation stage.



To contact the technical unit : Tel. +39 049 949 0289 - ufficiotecnico@geoplast.it

To download the updated technical sheets, the support material, new images and new case studies, visit our website:

Geoplast.it

GEOPLAST FOUNDATION



✓ VENTILATION

- They adapt to any type of situation thanks to the large range of heights, sizes and accessories.
- The structural performances of the building are improved thanks to the creation of a light but, at the same time, very resistant structure.
- Our systems can be used to create new structures, but also to improve the existent ones.
- They are easy to install and to move in the worksite, thanks to their lightness and modularity.
- The system allows the creation of a technical space that helps the elimination of rising damp and Radon Gas and helps the passage of pipes and installations.
- Our systems can be used in all fields: from restoration to private buildings, but also for the creation of industrial warehouses and perforated floorings for composting systems.
- They protect the waterproofing membrane of retaining walls from the contact with the ground, without altering its integrity and preventing water infiltrations.
- Our systems offer also many economical advantages comparing to the old fashioned solutions.

✓ LIGHTNESS



✓ PROTECTION

MODULO



PERMANENT CRAWL SPACE FORMWORK



MODULO ADVANTAGES



Modular and single-use formwork system for ventilated crawl spaces for the creation of a physical barrier between the ground and the building.

RADON GAS MITIGATION

Modulo system guarantees a uniform and natural air circulation that allows the elimination of damp and radon gas from the construction.

VOID SPACE

The void space created under MODULO allows an easy installation of electrical and mechanical systems as well as ventilation.

HIGH LOAD BEARING

Countless pillars, arches and domes create the highest load bearing structure.

LIGHTNESS

By far it is the lightest filling solution; the total weight of the cross section is approximately equal to the thickness of the upper slab.

FAST

When compared with traditional systems, it guarantees a faster installation up to the 80% (in respect to the use of the traditional inert materials).

STACKABLE

Unmatched logistical advantages when transporting and storing. At a height of 50 cm, conventional filling requires 50 trucks of filling in comparison to only 1 truck of MODULO.

RISK FOR YOUR HEALTH



ISSUES CAUSED BY RADON GAS

RADON is an odourless and colourless radioactive gas that can be found in variable quantities in the Earth's crust. The main source of environmental emission of this gas is the soil itself.

Radon tends to accumulate in closed, unventilated rooms of

buildings, especially in ground floors. In these areas, RADON can reach high concentration levels, thus creating very serious health hazards. This problem could be easily prevented if considered during the planning stage of the building.

THE ORIGIN OF RADON IN OUR HOUSES

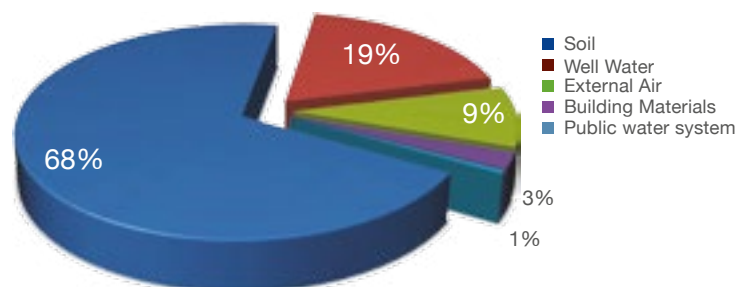

Source: ©Bob's Radon Mitigation

ISSUES CAUSED BY RISING DAMP

The soil is a heterogeneous mixture of solid elements, air and water. Water can cause serious issues when in contact with a traditional foundation: infiltrations, cold, humid and unhealthy environments. A properly

ventilated crawl space creates a physical barrier between the ground and the building and eliminates rising damp issues.

THE SOLUTION

It is possible to defend ourselves against RADON GAS and rising damp by using an effective ventilation system of the foundation. Modulo solution guarantees uniform and natural air circulation between the ground

level and the ground floor: a properly ventilated crawl space creates an "EMPTY SPACE", within the building and the ground, with many benefits for the building's health.

THE VENTILATED CRAWL SPACE



The creation of ventilated foundations, i.e. a void crawl space built under the flooring to improve the health and safety of the house. MODULO is a non-reusable formwork that eliminates rising damp and RADON GAS, which can naturally be found in the soil. MODULO allows the construction of a reinforced concrete structure provided with

a slab and a series of pillars placed at a fixed distance. Such a structure permits a uniform stress distribution all over the surface, thus producing an excellent load-bearing capacity, both static and dynamic. MODULO is made of regenerated and eco-friendly plastic materials, long-lasting and with a high mechanical resistance.



HOW IS IT CREATED?

MODULO is the most useful solution to take advantage of the CHIMNEY EFFECT. This effect can be obtained placing the inlet holes on the northern side and the outlet holes on the southern side at a higher point. In order to guarantee a uniform circulation, all the areas of the foundation must be connected together. The air

flow is guaranteed by the PVC pipes inside the wall that heat up and cause an upward movement of the air from the foundation. The ventilation of these areas connected with the outside is called chimney effect and permits the elimination of rising damp and the dispersion or Radon Gas.



WORMER
SIDE

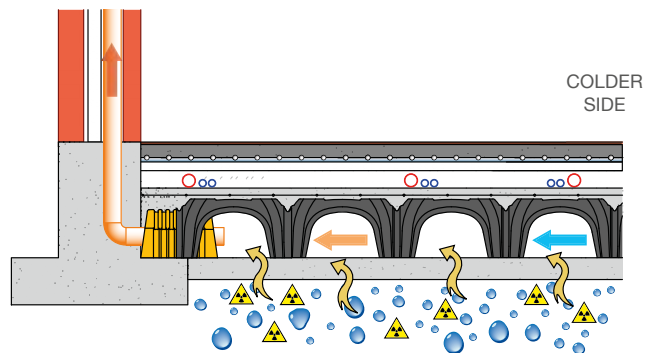

COLDER
SIDE

LIGHTENING OF SLABS

MODULO is also a lightening system that can offer many benefits. First, it is particularly useful in multi-storey buildings as the total structure becomes lighter with MODULO system. This lightness reduces the thickness of the slab, as well as the total load of the structure burdening on pillars and foundations. Second, there are savings both in terms of time, labour and material costs, because the amount of concrete and steel used is highly reduced. Finally, thanks to the creation of a void space in multi-storey buildings, MODULO ensures noise reduction, heat insulation and an higher living comfort.

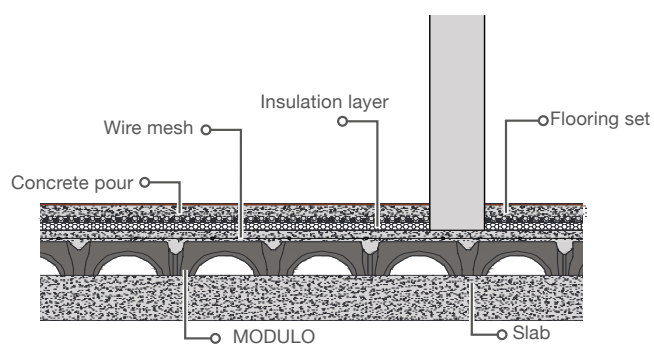
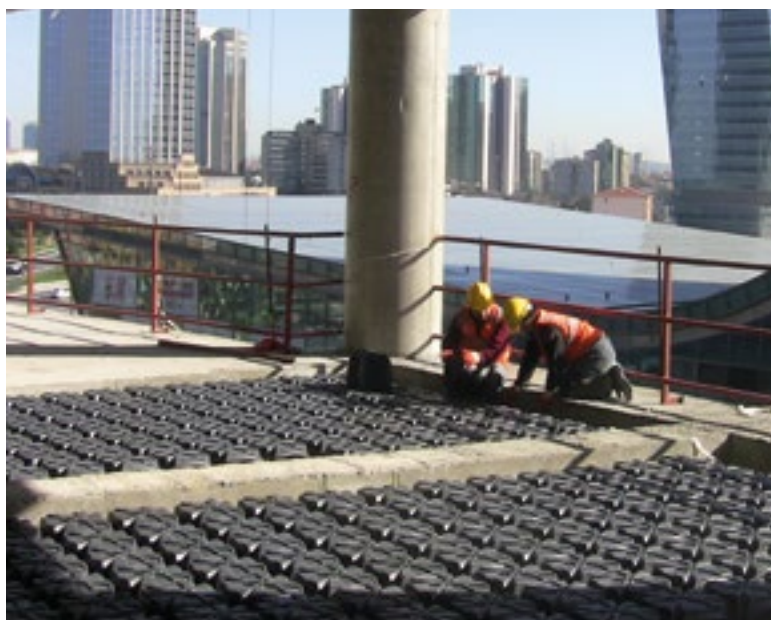

TECHNICAL VOID SPACE

With MODULO it is possible to raise the level of the floor and also create a structural void space that allows the passage of electrical, heating, ventilation, air conditioning and plumbing systems. This space allows an easy and economic functioning of the building. Cables and pipes can be laid before or after the construction and the maintenance is not invasive. Moreover, the implementation can be made in both new and renovated buildings. The surface is continuous unlike modular raised floors and has a very high load bearing capacity.

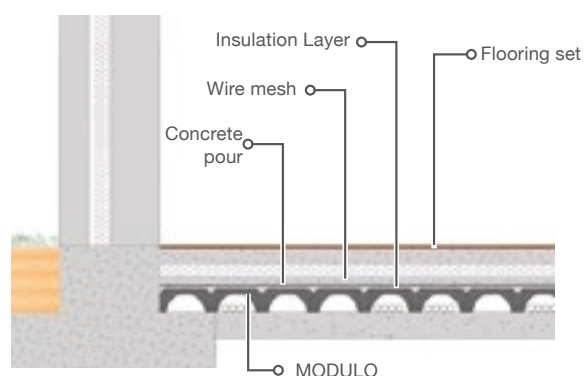

FILLING OF SLABS AND FOUNDATIONS

Thanks to its logistical advantages and lightness, MODULO is the best filling system. In comparison with traditional filling materials (such as: sand, gravel, etc...), MODULO is the lightest since the extra load of the filling is only the concrete that comes on top of the system. Moreover, when used on the roof of a building, it lightens the entire structure, favouring also the ventilation.

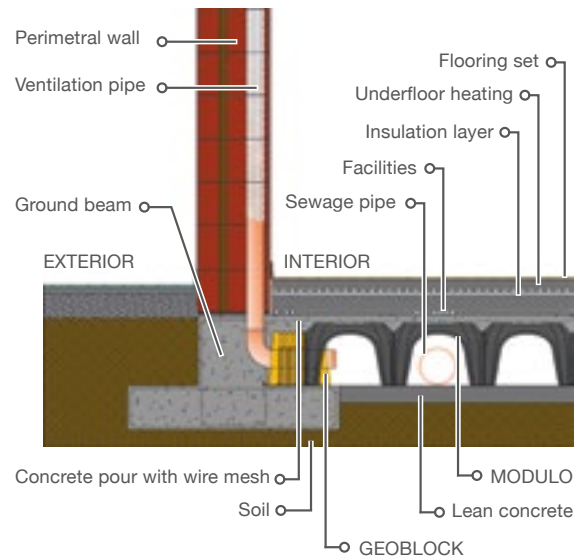

FRIDGE CELLS

Fridge cells and warehouses are increasingly common in food industry. There the freezing cold is transmitted through the building, downwards to the ground, taking it to a temperature below 0°C. In these situations a process known as frost heaving (or frost heave) occurs: when the water contained in the soil freezes, its volume increases and expands upwards, with a risk of raising the foundation package and consequently leading to the formation of warps and cracks on the floor.

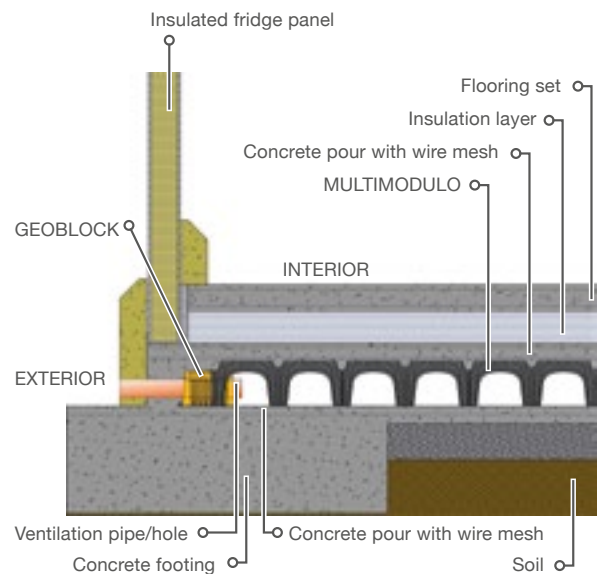

GREEN ROOF WALKWAYS

Green areas have always been an additional value to our cities. In small areas where there is not enough space to use, different levels solutions had to be taken into consideration so, the concept of green roof had to be introduced. Green roofs need walkways to cross the green areas as it happens in our gardens and MODULO large range of heights are the best solution.

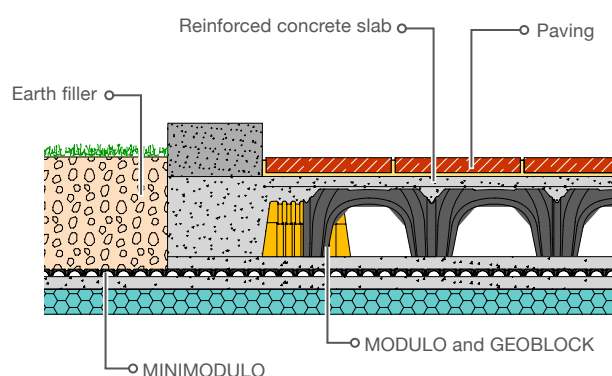

ACOUSTIC INSULATION

Modulo H6 is the best solution to control the noises in a building. It is placed between the screed and the slab structure and when implemented, it makes possible the increasing of the comfort level of the buildings. Modulo H6 offers also other benefits, its cavity is excellent for the passage of cables and pipes and it is also a less heavy solution than the classical screed. In combination with specific phono insulating packages Modulo h6 helps to approach the standard values specified by regulations in terms of noise, which depends on the building's use and on the specific laws and phono insulation parameters.

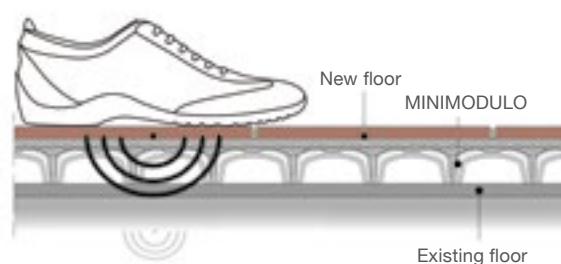

CASE HISTORY



Geoplast Products
Modulo & Geoblock



Ciudad de las artes y las ciencias, Spain
Santiago Calatrava e Félix Candela architects



Geoplast Product
Multimodulo



Morocco Mall, Morocco
Davide Padoa Design International

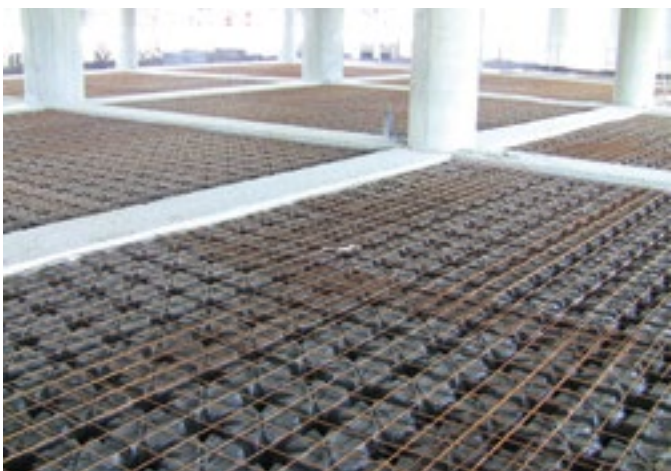

Geoplast Products
Modulo & Geoblock



Adnan Menderes Airport, Turkey
Yakup Hazan Architecture

A SUMMARY OF THE TECHNICAL DATA

MINIMODULO

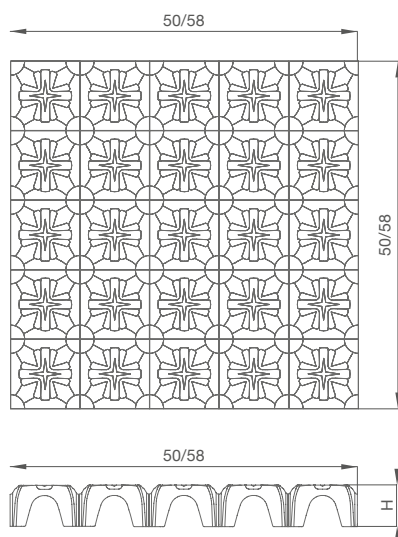

MODULO

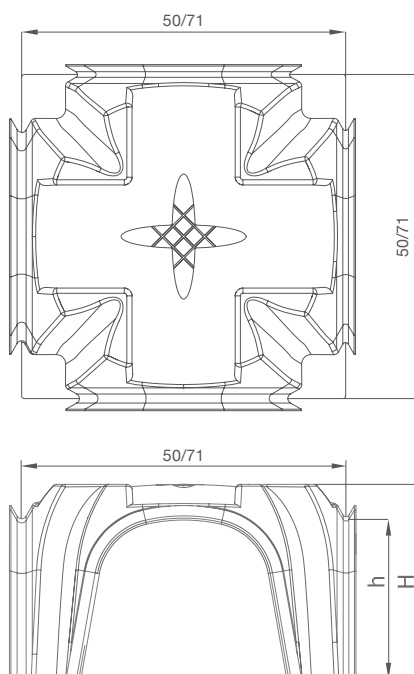

MULTIMODULO

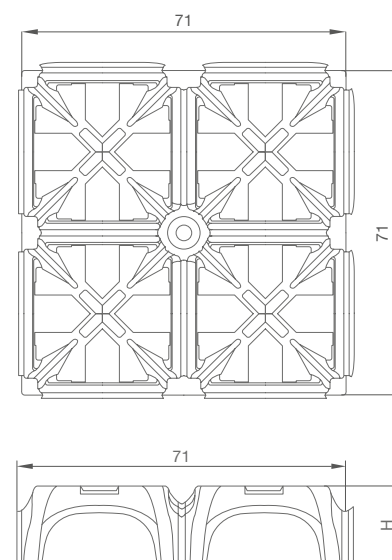

ACCESSORIES FOR VENTILATED FOUNDATIONS

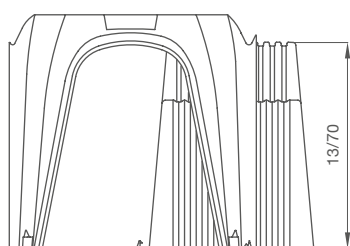

GEOBLOCK MODULO

HEIGHT from 13 to 70 cm
WEIGHT PCS. from 0,55 to 4,18 kg

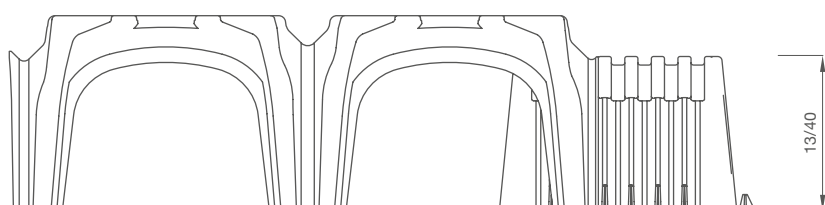

GEOBLOCK MULTIMODULO

HEIGHT from 13 to 40 cm
WEIGHT PCS. from 0,39 to 1,05 kg

THE EXTENSION GEOBLOCK

The combination of MODULO and GEOBLOCK allows the creation of a monolithic slab without the risk of cracks or breakages. The extension is an

adjustable product, adaptable to any worksite situation and available for every MODULO height.



WHAT ARE THE ADVANTAGES?

STRUCTURAL CONTINUITY

Single pour of crawl space and foundation beams

SAFETY IN THE WORKSITE

It is possible to walk over the formwork, especially along the perimeter, as there is always a complete element

ELIMINATION OF THE DOUBLE FORMWORK

Thanks to **GEOBLOCK** the beams does not need to be formed internally

COMPENSATION ADJUSTABILITY

The depth of **GEOBLOCK** extension can be modified

NO CUTTING OF THE FORMWORK

The distances can be compensated without cutting the formwork



CUTTING



NO CUTTING

THE PLANNING

GEOPLAST offers a planning service on the basis of a DWG analysis of the foundation, in order to

obtain a graphic file with an accurate counting of the pieces and a detailed installation scheme.



DIMENSIONS OF MINIMODULO - MODULO - MULTIMODULO

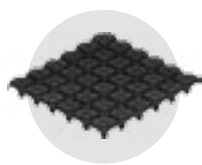

MINIMODULO H3 - H9

| | Dimensions (cm) | Concrete consumption m ³ /m ² | Package dim. (cm) | Package (m ²) | No. pieces | Weight per unit (kg) |
|------------------|-----------------|---|-------------------|---------------------------|------------|----------------------|
| MODULO H3 | 50 x 50 | 0,004 | 120 x 102 x H220 | 180 | 720 | 0,77 |
| MODULO H6 | 50 x 50 | 0,009 | 120 x 102 x H220 | 180 | 720 | 0,95 |
| MODULO H9 | 58 x 58 | 0,010 | 120 x 120 x H240 | 240 | 720 | 1,16 |



MODULO H13 - H40

| | Dimensions (cm) | Concrete consumption m ³ /m ² | Package dim. (cm) | Package (m ²) | No. pieces | Weight per unit (kg) |
|-------------------|-----------------|---|-------------------|---------------------------|------------|----------------------|
| MODULO H13 | 50 x 50 | 0,028 | 102 x 102 x H235 | 90 | 360 | 1,12 |
| MODULO H15 | 50 x 50 | 0,030 | 102 x 102 x H240 | 90 | 360 | 1,08 |
| MODULO H17 | 50 x 50 | 0,035 | 102 x 102 x H235 | 90 | 360 | 1,30 |
| MODULO H20 | 50 x 50 | 0,037 | 102 x 102 x H240 | 90 | 360 | 1,32 |
| MODULO H25 | 50 x 50 | 0,038 | 102 x 102 x H235 | 90 | 360 | 1,34 |
| MODULO H27 | 50 x 50 | 0,040 | 102 x 102 x H235 | 75 | 300 | 1,38 |
| MODULO H30 | 50 x 50 | 0,044 | 102 x 102 x H240 | 75 | 300 | 1,49 |
| MODULO H35 | 50 x 50 | 0,052 | 107 x 107 x H230 | 75 | 300 | 1,54 |
| MODULO H40 | 50 x 50 | 0,056 | 107 x 107 x H230 | 75 | 300 | 1,71 |



MODULO H45 - H70

| | Dimensions (cm) | Concrete consumption m ³ /m ² | Package dim. (cm) | Package (m ²) | No. pieces | Weight per unit (kg) |
|--------------------|-----------------|---|-------------------|---------------------------|------------|----------------------|
| MODULO H45 | 71 x 71 | 0,064 | 151 x 151 x H230 | 150 | 300 | 3,30 |
| MODULO H50 | 71 x 71 | 0,076 | 151 x 151 x H230 | 150 | 300 | 3,65 |
| MODULO H55 | 71 x 71 | 0,078 | 151 x 151 x H225 | 120 | 240 | 3,80 |
| MODULO H60 | 71 x 71 | 0,079 | 153 x 153 x H230 | 120 | 240 | 3,85 |
| MODULO H65* | 71 x 71 | 0,084 | 153 x 153 x H230 | 120 | 240 | 4,02 |
| MODULO H70* | 71 x 71 | 0,083 | 153 x 153 x H240 | 120 | 240 | 4,07 |



MULTIMODULO H13 - H40

| | Dimensions (cm) | Concrete consumption m ³ /m ² | Package dim. (cm) | Package (m ²) | No. pieces | Weight per unit (kg) |
|------------------------|-----------------|---|-------------------|---------------------------|------------|----------------------|
| MULTIMODULO H13 | 71 x 71 | 0,020 | 151 x 151 x H225 | 180 | 360 | 2,05 |
| MULTIMODULO H15 | 71 x 71 | 0,027 | 151 x 151 x H225 | 180 | 360 | 2,09 |
| MULTIMODULO H17 | 71 x 71 | 0,028 | 151 x 151 x H226 | 180 | 360 | 2,15 |
| MULTIMODULO H20 | 71 x 71 | 0,032 | 151 x 151 x H250 | 150 | 300 | 2,42 |
| MULTIMODULO H25 | 71 x 71 | 0,033 | 151 x 151 x H235 | 180 | 360 | 2,51 |
| MULTIMODULO H27 | 71 x 71 | 0,035 | 151 x 151 x H235 | 180 | 360 | 2,56 |
| MULTIMODULO H30 | 71 x 71 | 0,042 | 151 x 151 x H250 | 150 | 300 | 2,86 |
| MULTIMODULO H35 | 71 x 71 | 0,045 | 151 x 151 x H240 | 180 | 360 | 2,66 |
| MULTIMODULO H40 | 71 x 71 | 0,050 | 151 x 151 x H265 | 150 | 300 | 3,30 |

DIMENSIONS OF GEOBLOCK - ACCESSORIES



GEOBLOCK MODULO H13 - H70

| | Package dim. (cm) | No. pieces | Weight per unit (kg) |
|----------------------------|-------------------|------------|----------------------|
| GEOBLOCK MODULO H13 | 110 x 110 x H180 | 500 | 0,55 |
| GEOBLOCK MODULO H15 | 110 x 100 x H180 | 500 | 0,62 |
| GEOBLOCK MODULO H17 | 110 x 120 x H190 | 500 | 0,68 |
| GEOBLOCK MODULO H20 | 110 x 120 x H195 | 500 | 0,77 |
| GEOBLOCK MODULO H25 | 110 x 120 x H195 | 500 | 0,99 |
| GEOBLOCK MODULO H27 | 115 x 120 x H200 | 500 | 1,10 |
| GEOBLOCK MODULO H30 | 115 x 120 x H200 | 500 | 1,19 |
| GEOBLOCK MODULO H35 | 115 x 120 x H210 | 500 | 1,43 |
| GEOBLOCK MODULO H40 | 120 x 130 x H210 | 500 | 1,54 |
| GEOBLOCK MODULO H45 | 100 x 120 x H220 | 200 | 2,62 |
| GEOBLOCK MODULO H50 | 100 x 120 x H225 | 200 | 2,86 |
| GEOBLOCK MODULO H55 | 106 x 120 x H230 | 200 | 3,56 |
| GEOBLOCK MODULO H60 | 106 x 120 x H240 | 200 | 3,64 |
| GEOBLOCK MODULO H65 | 110 x 120 x H240 | 200 | 4,07 |
| GEOBLOCK MODULO H70 | 110 x 120 x H245 | 200 | 4,18 |



GEOBLOCK MULTIMODULO H13 - H40

| | Package dim. (cm) | No. pieces | Weight per unit (kg) |
|---------------------------------|-------------------|------------|----------------------|
| GEOBLOCK MULTIMODULO H13 | 120 x 100 x H110 | 500 | 0,39 |
| GEOBLOCK MULTIMODULO H15 | 110 x 93 x H110 | 500 | 0,41 |
| GEOBLOCK MULTIMODULO H17 | 121 x 93 x H110 | 500 | 0,48 |
| GEOBLOCK MULTIMODULO H20 | 110 x 97 x H120 | 500 | 0,52 |
| GEOBLOCK MULTIMODULO H25 | 122 x 100 x H120 | 500 | 0,69 |
| GEOBLOCK MULTIMODULO H27 | 120 x 102 x H130 | 500 | 0,72 |
| GEOBLOCK MULTIMODULO H30 | 120 x 102 x H130 | 500 | 0,78 |
| GEOBLOCK MULTIMODULO H35 | 124 x 103 x H140 | 500 | 0,94 |
| GEOBLOCK MULTIMODULO H40 | 125 x 107 x H140 | 500 | 1,05 |



ACCESSORIES OF MULTIMODULO SYSTEM

FERMAGETTO IN PLASTIC PAPERBOARD

Side closure element for MULTIMODULO heights from 13 to 40 cm



ACCESSORIES OF MODULO SYSTEM

FERMAGETTO MODULO

This element prevents the intrusion of concrete in the crawl space. It is available for MODULO heights from 13 to 40 cm



ACCESSORIES OF MODULO SYSTEM

FERMAGETTO IN PLASTIC PAPERBOARD

Side closure element for MODULO heights from 45 to 70 cm

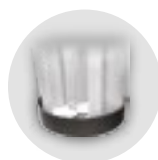

ACCESSORIES OF MODULO SYSTEM

*RING

retaining for MODULO H65 e H70

LOAD TABLES

MINIMODULO

| LOAD (Kg/m ²) | THICKNESS of the slab (cm)* | WIRE MESH (mm) | THICKNESS lean concrete (cm) | THICKNESS gravel (cm) | GROUND pressure (Kg/cm ²) |
|---------------------------|-----------------------------|----------------|------------------------------|-----------------------|---------------------------------------|
| 500 | 5 | Ø5/25x25 | 5 | | 0,21 |
| 1,000 | 5 | Ø6/20x20 | 5 | | 0,42 |
| 2,500 | 5 | Ø6/20x20 | 5 | | 1,06 |
| 5,000 | 5 | Ø8/20x20 | 10 | | 0,76 |
| 10,000 | 6 | Ø10/20x20 | 5 | 10 | 0,77 |

> 10,000

To evaluate each case, please contact Geoplast Technical Department

MODULO 50 X 50

| LOAD (Kg/m ²) | THICKNESS of the slab (cm)* | WIRE MESH (mm) | THICKNESS lean concrete (cm) | THICKNESS gravel (cm) | GROUND pressure (Kg/cm ²) |
|---------------------------|-----------------------------|----------------|------------------------------|-----------------------|---------------------------------------|
| 500 | 5 | Ø5/25x25 | 5 | | 0,29 |
| 1,000 | 5 | Ø6/20x20 | 5 | | 0,58 |
| 2,500 | 5 | Ø8/20x20 | 10 | | 0,72 |
| 5,000 | 6 | Ø8/20x20 | 5 | 10 | 0,90 |
| 10,000 | 8 | Ø10/20x20 | 5 | 15 | 1,10 |

> 10,000

To evaluate each case, please contact Geoplast Technical Department

MODULO 71 X 71

| LOAD (Kg/m ²) | THICKNESS of the slab (cm)* | WIRE MESH (mm) | THICKNESS lean concrete (cm) | THICKNESS gravel (cm) | GROUND pressure (Kg/cm ²) |
|---------------------------|-----------------------------|----------------|------------------------------|-----------------------|---------------------------------------|
| 500 | 5 | Ø5/25x25 | 5 | | 0,42 |
| 1,000 | 5 | Ø6/20x20 | 5 | | 0,85 |
| 2,500 | 6 | Ø8/20x20 | 10 | | 1,14 |
| 5,000 | 7 | Ø8/20x20 | 5 | 10 | 1,42 |
| 8,000 | 10 | Ø10/20x20 | 5 | 15 | 1,35 |

> 10,000

To evaluate each case, please contact Geoplast Technical Department

MULTIMODULO

| LOAD (Kg/m ²) | THICKNESS of the slab (cm)* | WIRE MESH (mm) | THICKNESS lean concrete (cm) | THICKNESS gravel (cm) | GROUND pressure (Kg/cm ²) |
|---------------------------|-----------------------------|----------------|------------------------------|-----------------------|---------------------------------------|
| 500 | 5 | Ø5/25x25 | 5 | | 0,21 |
| 1,000 | 5 | Ø6/20x20 | 5 | | 0,41 |
| 2,500 | 5 | Ø6/20x20 | 5 | | 1,03 |
| 5,000 | 5 | Ø8/20x20 | 10 | | 0,85 |
| 10,000 | 6 | Ø8/20x20 | 5 | 15 | 1,07 |

> 10,000

To evaluate each case, please contact Geoplast Technical Department

*Concrete class C20/25 minimum

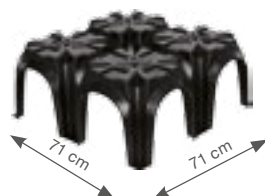
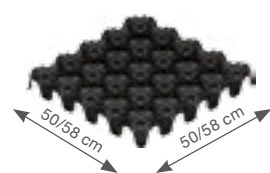

INSTALLATION OF MODULO + GEOBLOCK



① PREPARATION

Creation of a laying surface with lean concrete and installation of the external formwork and the reinforcements of the perimeteral beams.



② FACILITIES

Installation of the pipes to place them into the perimeteral ventilation holes and then place of the possible channeling systems for the pipes.



③ FORMWORK

Installation of MODULO formwork following the instructions, from right to left as marked in the formwork, without any cutting.



④ GEOBLOCK

Installation of GEOBLOCK to get closer to the reinforcements of the foundation: in this way GEOBLOCK permits the shuttering of the beams.



⑤ REINFORCEMENT

Installation of the load distribution mesh on MODULO formwork and connect it to the foundation beams reinforcement.



⑥ SINGLE POUR

Pour of the beams and the foundation slabs. Follow the instruction in order to pour correctly.

MODULO formwork system must be installed FROM RIGHT TO LEFT AND FROM TOP TO BOTTOM, keeping the molded arrows pointing towards and to the left.

It is essential to verify the correct anchoring of the feet!

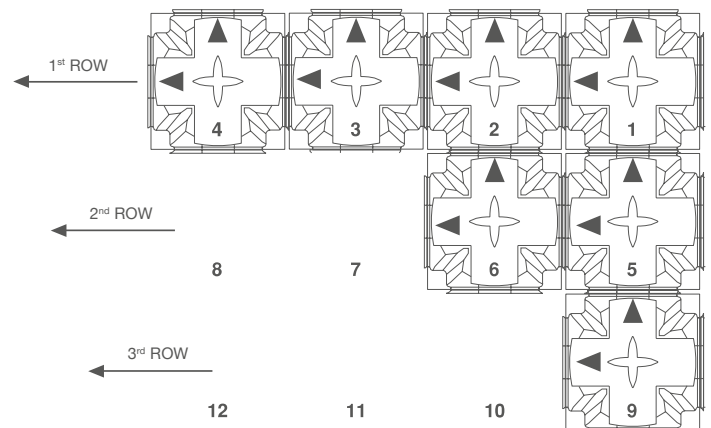

NEW ELEVATOR



**PERMANENT CRAWL SPACE FORMWORK,
UP TO 3 M**



NEW ELEVETOR ADVANTAGES



Modular and single-use formwork system for crawl spaces up to 300 cm for the creation of a physical barrier between the ground and the building.

STACKABLE

Unmatched logistical advantages when transporting and storing. At a height of 50 cm, conventional filling requires 50 trucks of filling in comparison to only 1 truck of NEW ELEVETOR.

LIGHTNESS

By far it is the lightest filling solution; the total weight of the cross section is approximately equal to the thickness of the upper slab.

HIGH LOAD BEARING

Countless pillars, arches and domes create the highest load bearing structure.

VOID SPACE

The void space created under NEW ELEVETOR allows an easy installation of electrical as well as mechanical systems. The void space is also perfect to ventilate damp and RADON GAS away from the building.

FAST

When compared to traditional systems, it guarantees faster installation times up to the 80% (in respect to the use of the traditional inert materials).

SAVINGS

NEW ELEVETOR system allows savings compared to the use of traditional inert materials, especially in terms of transport and installation.

TECHNICAL CHART NEW ELEVETOR

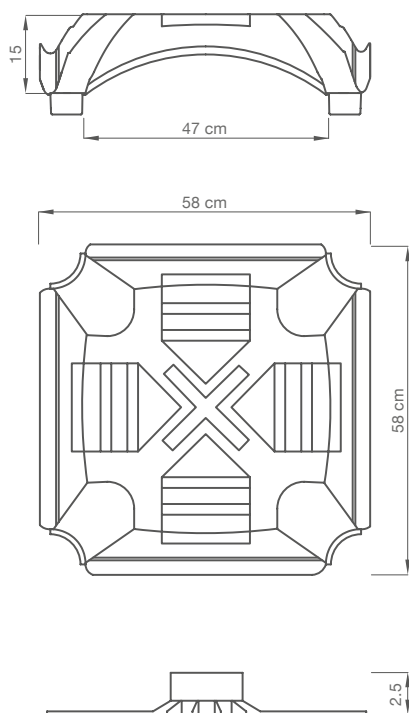

FORMWORK



GRID

| | | |
|-----------------------|-----------------|-----------------|
| Actual size (cm) | 58 x 58 x 15 | 58 x 58 x 2.5 |
| Material | Polypropylene | Polypropylene |
| Weight (kg) | 1.78 | 0.52 |
| Package size (cm) | 120 x 120 x 265 | 110 x 110 x 240 |
| No. pieces per pallet | 225 | 310 |



PIPE



LINTEL

| | | |
|------------------|------------------|--------------|
| Actual size (cm) | 75 > 300 x ø12.5 | 8 x 10 x 100 |
| Material | PVC | Polystyrene |

CONCRETE CONSUMPTION UP TO THE TOP (m³/m²)

$$[0,037 \times (\text{height Elevator in m} - 0,15)] + 0,030 \text{ m}^3/\text{m}^2$$

THE PIPE

The supporting structure consists in a classical construction pipe of PVC with an external diameter of 125 mm and a thickness of 1.8 mm. When the pipes are inserted into the patented base grid and filled with concrete, they support structurally the upper formwork.

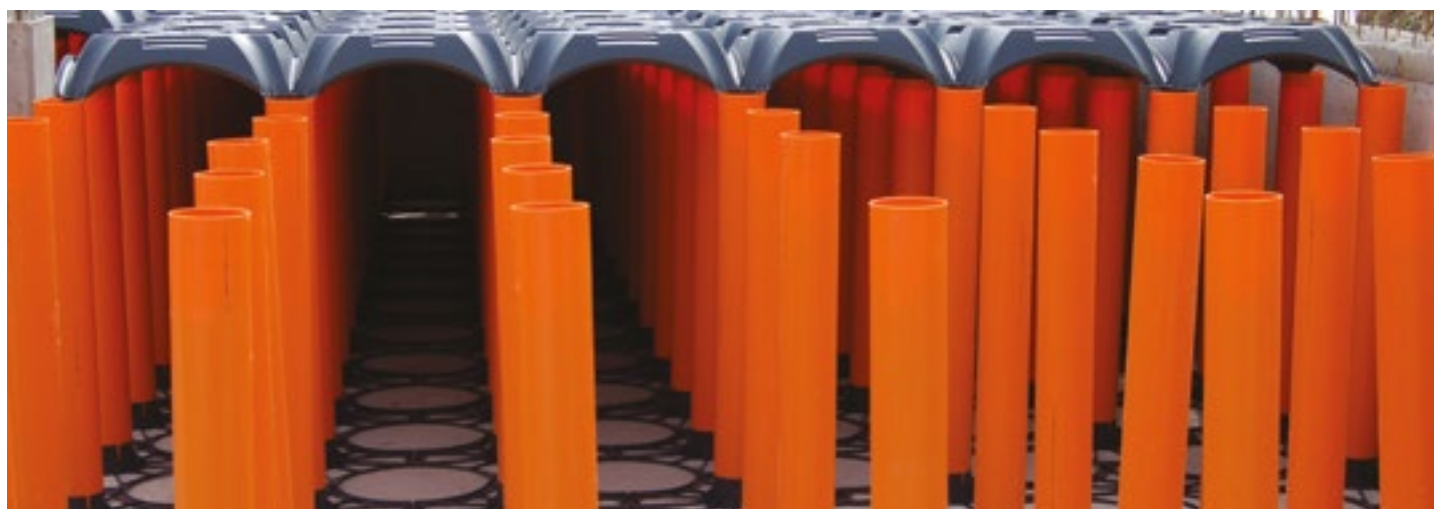

NEW ELEVATOR SYSTEM: THE CONCEPT



This system is ideal for the ventilation of reinforced concrete foundation slabs for residential, industrial and commercial buildings. The product consists of a formwork, PVC pipes and a patented grid that guarantees the system perfect verticality in order to ensure a great load-bearing capacity. The system is modular and the formwork can be installed on-site in order to build a walkable and self supporting system which is ready for the concrete pour. When the concrete solidifies, it takes the form of NEW ELEVATOR, thus creating a supporting and completely ventilated crawl space.

FORMWORK

The formwork is a dome made of regenerated PP (polypropylene) with plan size of 58X58 and an height of 15cm, with a bottom click rail to hook it perfectly to the pipes. The dome geometry allows a uniform load-bearing capacity over the four pillars. Moreover, it permits the reduction of the upper slab thickness.

DETAILS AND ADVANTAGES OF THE GRID

The base grid, essential for NEW ELEVATOR system, is made of regenerated PP and allows the perfect verticality of the pipes of PVC. The single grids are locked with one another creating a solid base grid that guarantees the stability and the walkability of the final structure.



INSTALLATION OF NEW ELEVETOR

THE CORRECT INSTALLATION OF NEW ELEVETOR SYSTEM



① GRID

Installation of the base grid, essential for the pipes verticality and the structural resistance.



② PIPES

Place the pipes of PVC in the base grids.



③ FORMWORK

Place New Elevator from right to left and interlock in the pipes to guarantee a safe walkability.



④ COMPENSATION

In the starting sides, where the formwork leans against the wall, the listels of polystyrene avoid the concrete dispersion.

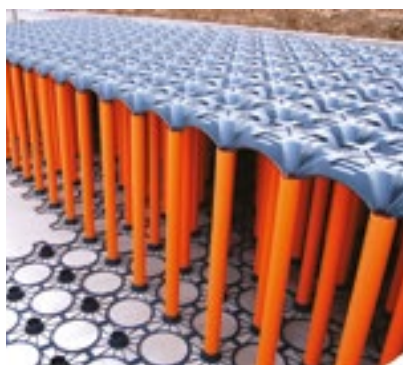

⑤ UPPER MESH

The upper mesh has to be placed right over the formwork or when required by the project over the spacers with an appropriate overlapping.



⑥ CONCRETE POUR

The pour comes after the end of the mesh installation. Pour concrete gradually from a side to the other and vibrate it properly.

LAYING SEQUENCE

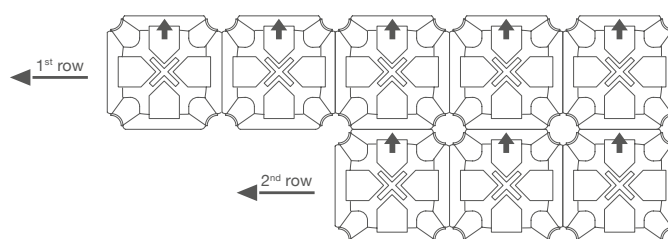
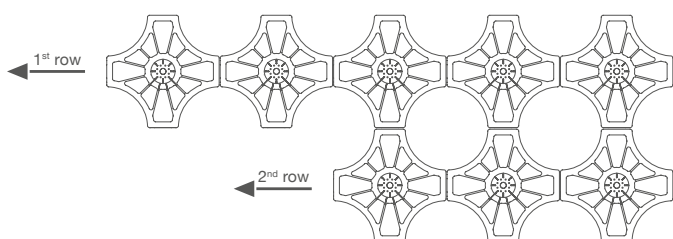

NEW ELEVATOR THE FINISHED SYSTEM

The construction of a ventilated crawl space with NEW ELEVATOR requires different stratigraphies depending on the final destination of the building and the working loads. The main sections of a finished stratigraphy with NEW ELEVATOR system are depicted in the following picture:

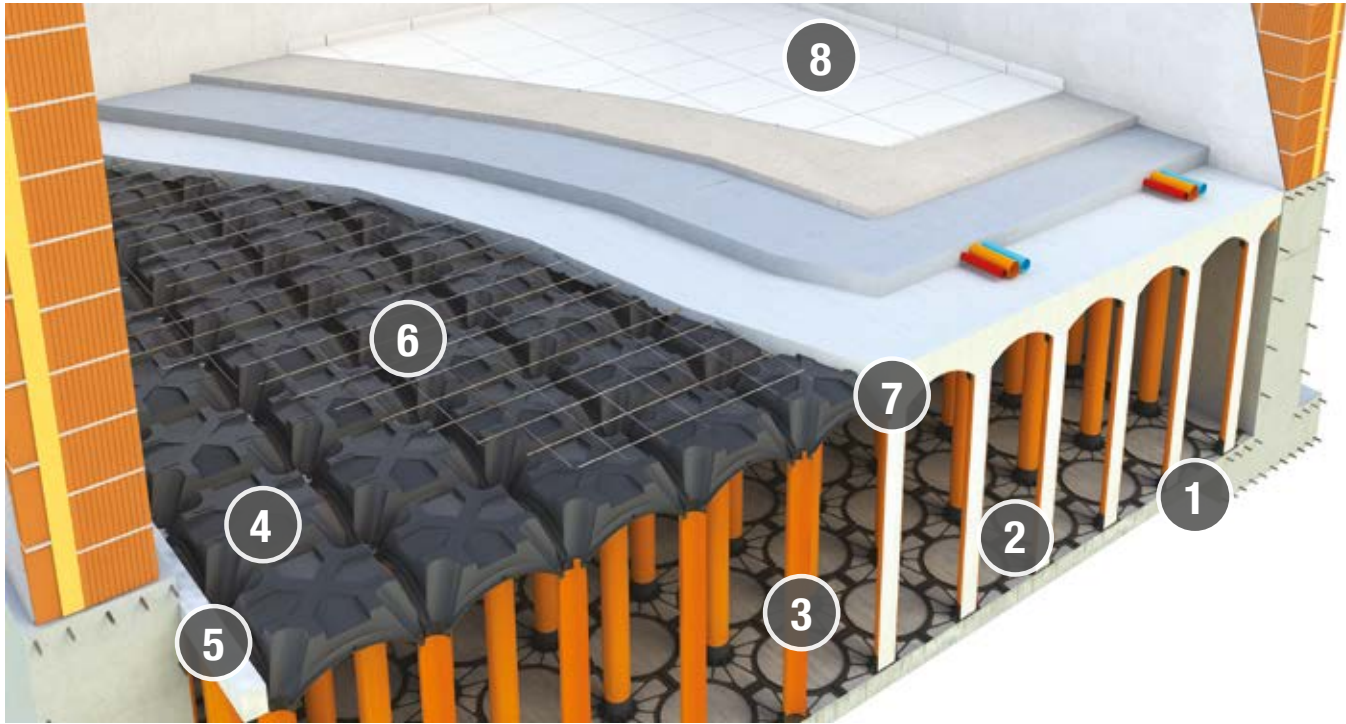

- ① LEAN CONCRETE
- ② GRID NEW ELEVATOR
- ③ PIPE NEW ELEVATOR
- ④ FORMWORK NEW ELEVATOR
- ⑤ LISTEL
- ⑥ WIRE MESH
- ⑦ FOUNDATION SLAB
- ⑧ PAVEMENT

PRESSURE WHEN IN CONTACT WITH SOIL FOR NEW ELEVATOR SYSTEM*

| Load daN/m ² | Slab thickness cm* | Reinforcement | Self weight daN/m ² | Concrete thickness (cm) | Pressure from N/m ² | Gravel thickness cm | Soil pressure from N/m ² |
|-------------------------|--------------------|---------------|--------------------------------|-------------------------|--------------------------------|---------------------|-------------------------------------|
| 1000.0 | 5.0 | Ø6/20x20 | 323.12 | 0.00 | 3.89 | 0.00 | 3.89 |
| | | | | 5.00 | 1.20 | 0.00 | 1.20 |
| | | | | 5.00 | 1.20 | 10.00 | 0.46 |
| | | | | 10.00 | 0.58 | 0.00 | 0.58 |
| 2500.0 | 5.0 | Ø8/20x20 | 323.12 | 5.00 | 2.47 | 0.00 | 2.47 |
| | | | | 5.00 | 2.47 | 10.00 | 0.94 |
| | | | | 10.00 | 1.18 | 0.00 | 1.18 |
| | | | | 10.00 | 1.18 | 10.00 | 0.58 |
| 5000.0 | 7.0 | Ø8/25x25 | 373.12 | 5.00 | 4.64 | 0.00 | 4.64 |
| | | | | 5.00 | 4.64 | 10.00 | 1.76 |
| | | | | 10.00 | 2.22 | 10.00 | 1.09 |
| | | | | 10.00 | 2.22 | 15.00 | 0.82 |
| 10000.0 | 10.0 | Ø10/20x20 | 448.12 | 5.00 | 8.95 | 30.00 | 1.09 |
| | | | | 10.00 | 4.29 | 15.00 | 1.58 |
| | | | | 10.00 | 4.29 | 20.00 | 1.24 |
| | | | | 15.00 | 2.51 | 20.00 | 0.91 |

*It is considered a configuration with New Elevator elements when the legs are placed at a height of 150 cm and 58 cm equidistant from each other. The concrete consumption of the system (without considering a possible slab) can be calculated in this way: 0.037 (height of New Elevator system 0.15) + 0.030 = [m³/m²]. For loads which are different from those listed, please contact Geoplast's technical unit.

**Concrete class C20/25 minimum

LARGE SCALE STRUCTURES

Thanks to its easy installation, with NEW ELEVATOR system it is possible to fill excavations filling and overcoming gaps quickly even in the case of large foundations. With low concrete consumption it creates a slab over pillars that guarantees very high load-bearing capacity and permits the transit of vehicles. Compared to a traditional filling with inert materials, it simplifies the logistics and installation. Moreover, the so created void space can be used for the installation of conduits or the creation of water storage tanks.

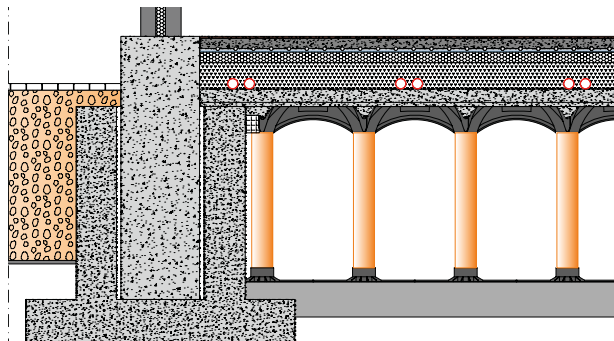

Material storage in the construction site

INDUSTRIAL BUILDINGS

The system allows the construction on-site of high crawl spaces, avoiding having to fill them with inert material and making it possible to use the so-created space for the installation of wires or pipes. The structure of reinforced concrete that can be built with NEW ELEVATOR is comparable to a floor slab supported by pillars. This guarantees an high load-bearing capacity against both permanent and accidental loads, which are typical of industrial environments.

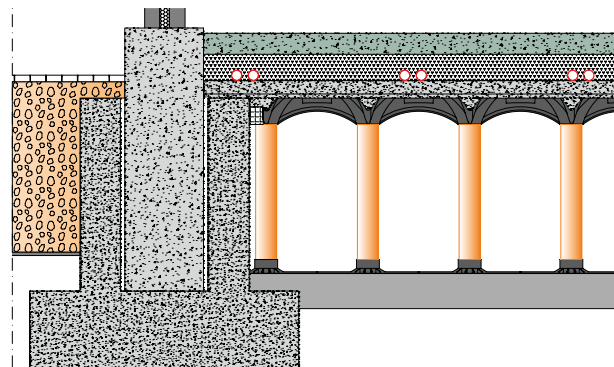

Reinforcement of the pillar with steel forks

RESIDENTIAL BUILDINGS

ELEVETOR creates a gap of variable height in order to protect the residential buildings from the rising damp and RADON, a radioactive gas from the subsoil which is harmful to human health. In the case of low load-bearing capacity ground it is necessary to build deeper foundations. NEW ELEVETOR system allows to avoid the filling with inert materials creating a large crawl space that can be used for various purposes.

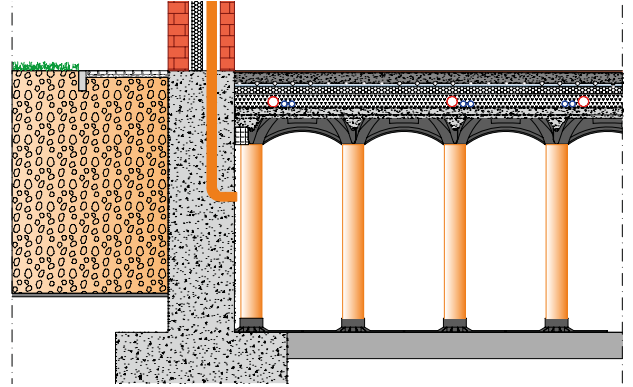

ACCESS RAMPS

Thanks to its modularity, NEW ELEVETOR system allows the over coming of the level differences, even for the transit of heavy vehicles or trucks. The ramp can be built in two ways:

- Inserting the inclined domes in the pipe (inclination up to 5%);
- Shaping the pipes in order to create a step and placing the domes horizontally (step's maximum height: 8 cm); the maximum slope and applied loads must be first arranged with Geoplast Technical Department.

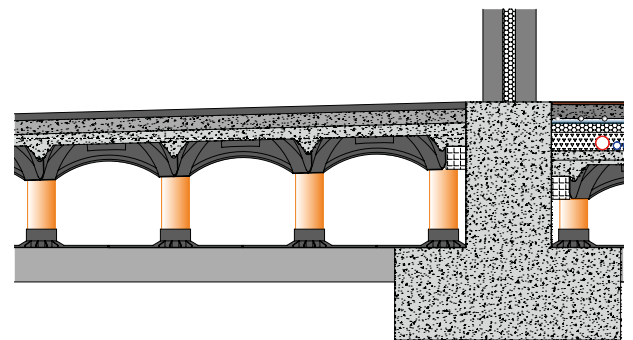

Ramp with finished slope

ROOTS APPLICATION

NEW ELEVATOR ROOTS is used to preserve the growth of tree roots along the roadway. Usually, the rooting space is hindered by cables, sewages or road underground layers. All these hindrances steal space to the roots which cause the typical upheaval of the road surface. Our solution considers the use of a slab placed at the top of a column grid in order to let the roots grow between the pipes.

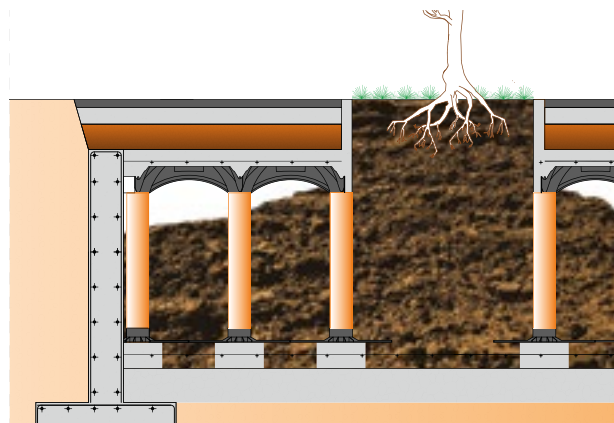

Section of Elevator Root system

NEW ELEVATOR TANK

NEW ELEVATOR TANK is the ideal solution for the fast construction of storage concrete tanks of variable height which can be used for the storage of high quantities of rainwater in a small space. The tank can be inspected through a pit that allows cleaning, checking the water level, the system's functionality and the microbiological status of the water.

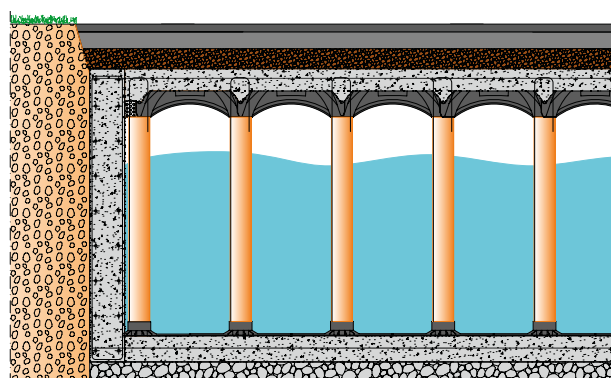

Rainwater storage tanks up to 300 cm

STEPPED SURFACES

NEW ELEVETOR allows the construction of structures with various levels such as staircases or stepped extensions. The simple and fast installation of the system avoids the filling with inert materials whom would be very complicated to deal with, especially in the contact points between areas placed at different heights.

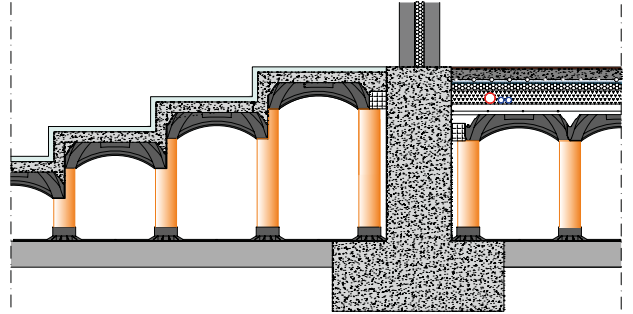

Detail of the formwork installation

INSPECTION MAN-HOLES

The inspection man-holes facilitate the checking and maintenance of the storage tanks. The gap between the pillars make it easy to move within the structure, thus giving the possibility to inspect the tank even afterwards.

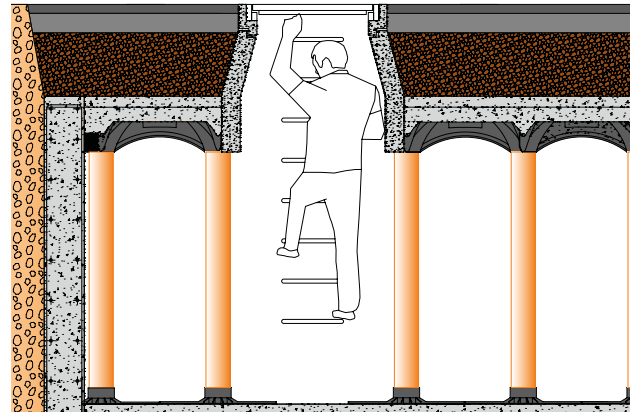

CASE HISTORY



New Elevetor Product



Emaar Square, Turkey



New Elevetor Product



Gare de Sarcelles, France



New Elevetor Product



TRM Incenerator, Italy

BIOMODULO



**PERMANENT FORMWORK FOR AIR
DIFFUSION IN COMPOSTING PLANTS
AND DEODORIZATION SYSTEMS**



BIOMODULO ADVANTAGES



Disposable formwork for the creation of perforated and self-supporting floorings for bio-filters and systems for the aerobic treatment of solid wastes.

EASY



BIOMODULO is very easy and intuitive to install, differently from the other traditional systems.

QUICK



The lightness and the use of compensation accessories guarantee a quick implementation of the system.

VENTILATION



Thanks to the holes and to the nozzles conformation, a uniform distribution of the air all over the surface is possible.

RESISTANT



BIOMODULO flooring guarantees the transit of heavy vehicles for loading and unloading operations.

INSPECTABLE



Thanks to BIOMODULO structure, inspection and system maintenance are facilitated.

EFFECTIVE



Thanks to an optimized efficiency of the process, the quality of the material is better than the other systems with the same characteristics.

BIOMODULO TECHNICAL DATA

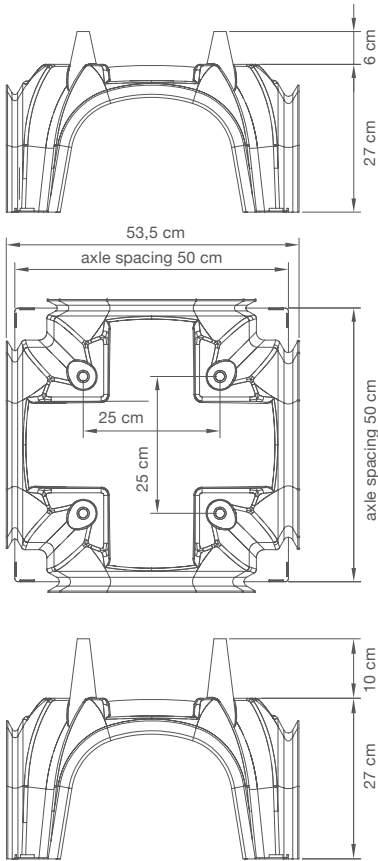

**BIOMODULO
H6**



**BIOMODULO
H10**

| Real size (cm) | 50 x 50 x 33 | 50 x 50 x 37 |
|-----------------------------|-----------------|-----------------|
| nozzles height (cm) | 6 | 10 |
| free span height (cm) | 21 | 21 |
| free span lenght (cm) | 34 | 34 |
| pipe max. ø (1) (mm) | 200 | 200 |
| 2 pipes max. ø (2) (mm) | 160 | 160 |
| Material | PP | PP |
| level filling concr. (m3m2) | 0,10 | 0,14 |
| Weight (kg) | 1,49 | 1,82 |
| Packaging Size (cm) | 103 x 103 x 245 | 103 x 103 x 255 |
| N° pcs. per pallet | 300 | 300 |
| m2 per pallet | 75 | 75 |
| nozzles base ø (mm) | 45 | 45 |
| air outlet holes ø (mm) | 16,5 | 16,5 |



**BIOMODULO
H6**



**BIOMODULO
H10**

LOAD WITH HEAVY VEHICLES

| 10.000 | 15.000 | Distributed overload (kg/m ²) |
|-----------|-----------|--|
| 6 | 10 | Hood thickness (cm)* |
| Ø10/20x20 | Ø10/20x20 | Net Type (mm/cm) |
| 10 | 10 | Weak concrete pression (kg/cm ²) |
| 2,8 | 4 | Pressure under weak concrete |
| 25 | 25 | Ground pression (kg/cm ²) |
| 0,826 | 1 | Pressure under gravel (kg/cm ²) |

*Concrete class C20/25 minimum

INSTALLATION OF BIOMODULO

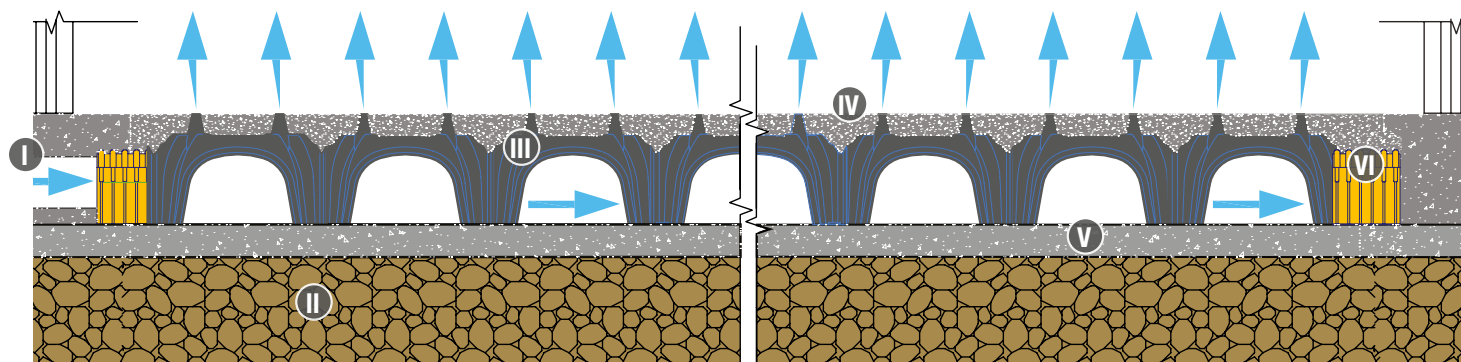

I - AIR INLET PIPE
II - GRAVEL
III - BIOMODULO

IV - REINFORCED CONCRETE POUR
V - WEAK CONCRETE
VI - GEOBLOCK

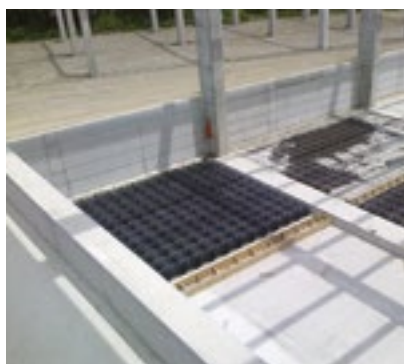

① SUBFLOOR CREATION

Creation of the supporting subfloor. A layer of rolling gravel (25cm), weak concrete (10cm) and a insulating layer made of HDPE (required in the composting system), are recommended.



② BIOMODULO INSTALLATION

Manual installation of BIOMODULO with closing caps and of the compensation system Geoblock and Fermagetto. Then, creation of the inspection channels with Geoblock.



③ WELDED MESH INSTALLATION

Place of the sector welded mesh.

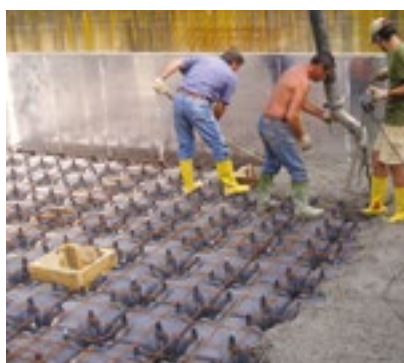

④ CONCRETE POUR

Concrete filling pour, strength class $R_{ck}' = 250 \text{ kg/cm}^2$ and consistency class S4. Subsequent pour vibration.



⑤ POUR SMOOTHING

Pour smoothing to create a uniform layer.



⑥ CAPS REMOVAL

Removal of the nozzles closure caps, to allow the inlet air passage.

AEROBICS STABILISATION SYSTEMS

BIOMODULO allows the creation of a perforated flooring, with a uniform distribution of the holes all over the surface. This facilitates a uniform diffusion of the air within the waste, in order to optimize the process and obtain a high quality final product. BIOMODULO structure has an high resistance to loads, allowing the transit of the machinery for the load and unload of the material or for the waste of mechanic treatment.



BIO-FILTERS

BIOMODULO allows the creation of perforated floorings that make the air flow in the bio-filter. The system can be used with any type of structure (steel or concrete) and can be adapted to the shape of the tank using Geoblock accessories and Fermagetto. The regular distribution of the holes allows the uniform diffusion of air within the filtration material where the purification takes place increasing the process efficiency.

BIOMODULO structure is completely transitable, in order to facilitate the periodic replacement of the filtration material.



DEFENDER



MODULAR PANEL FOR THE PROTECTION OF BASEMENT WALLS



DEFENDER ADVANTAGES



It combines the advantages of dimpled membrane and gravel, suitable for better protection of the waterproofing and ventilation of the basement walls.

RESISTANT



Effective sheath protection from impact and puncture during backfill operations; excellent mechanical performance regarding the horizontal thrust of the soil.

QUICK



Suitable for large areas, even with few elements thanks to the size of the panel. The reduced weight and bulk of the single panel facilitate handling and installation, even with a single worker.

MODULAR



Easier installation thanks to the modularity of the elements and the overlapping locking system.

VENTILATED



The particular shape of the panel allows to create a ventilated gap of 7 cm that is essential for the creation of an anti-root barrier.

PERMEABLE



Excellent draining capacity, thanks to the special overlapping locking system.

STACKABLE



The panels are easy to store and stack on pallets.

BASEMENT WALLS WATERPROOFING CONCEPT

DEFENDER is a panel in regenerated polypropylene (PP) that allows to create a protection barrier for basements and underground walls. The product has a double protective function:

- Protection of the waterproofing during backfill;
- Creation of an air gap that reduces moisture problems and decreases the so-called cold-wall effect.

DEFENDER SYSTEM

- ① WATERPROOFING
- ② DEFENDER
- ③ BACKFILL
- ④ DRAINAGE PIPE

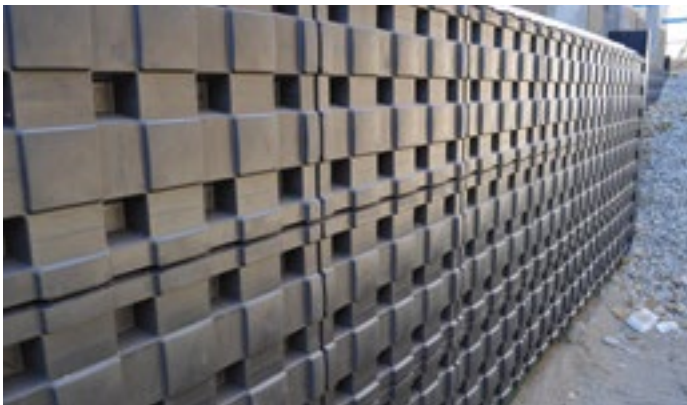
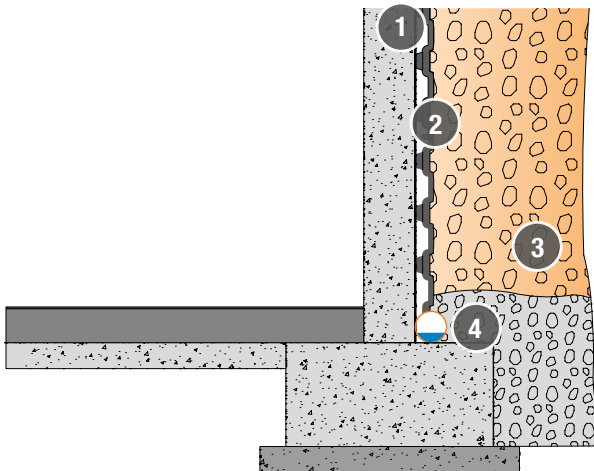

TRADITIONAL SYSTEM

- ① WATERPROOFING
- ② DIMPLED MEMBRANE
- ③ GRAVEL (50/80 CM)
- ④ BACKFILL
- ⑤ DRAINAGE PIPE

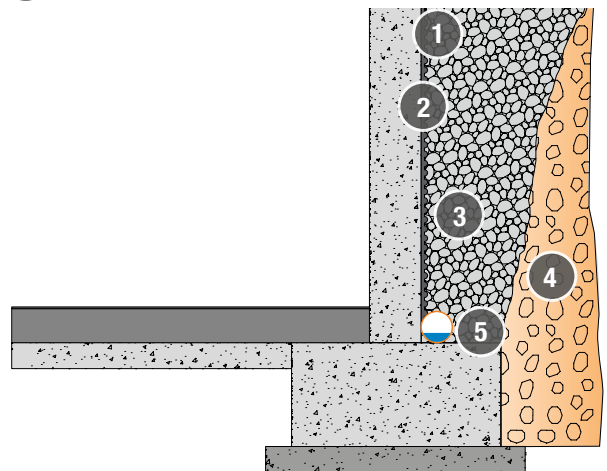

DEFENDER THE SYSTEM

Panel in recycled PP for the protection of basement walls.

Thanks to its strengthness, DEFENDER allows the backfill directly with the material from the excavation. The special locking system avoids the panel to be dragged downwards due to the setting of the ground, thus preserving the effectiveness over time of the waterproofing system.

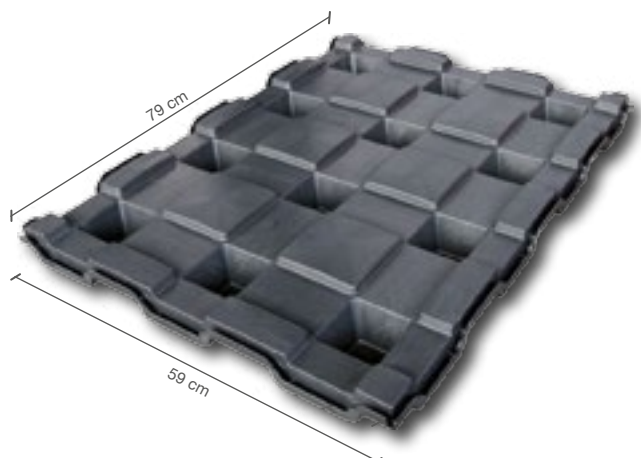

DEFENDER

| | |
|--|-----------------|
| Actual size (cm) | 79 x 59 x H7 |
| material | Polypropylene |
| weight (kg) | 2 |
| package dim. (cm) | 85 x 120 x H233 |
| No. items per pallet | 200 |
| Res. to compression (Kg/m ²) | 6.000 |

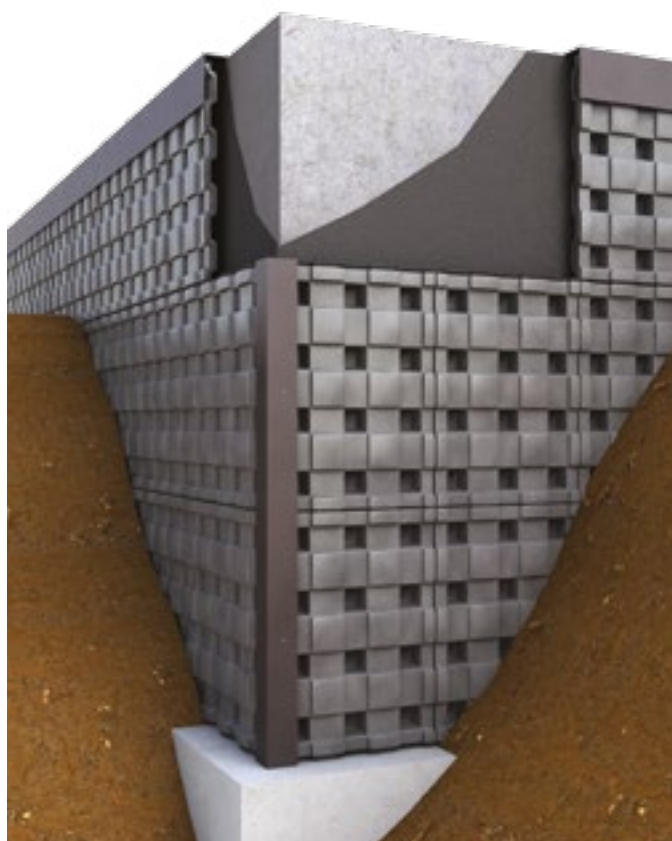

PROTECTION

Waterproofing of basement walls must be properly designed and executed. As remedial measures are hardly possible, the coating should resist as long as the wall: this is why a bad waterproofing (or no waterproofing at all) can cause considerable economic damages. The chosen materials should therefore maintain their impermeability to water, their resistance and mechanical strength over time, even when subjected to the traffic of the construction site.

DEFENDER panel is the best solution to these requirements.

**NO MOISTURE
DRY WALLS
PROTECTED SHEATHS**

DEFENDER VENTILATED AIR GAP

The complete ventilation guaranteed by the air gap created with DEFENDER panels creates better environmental conditions, less moisture problems and reduced cold-wall effect in the basements. Thanks to the 7 cm thick air gap,

DEFENDER ensures excellent drainage capacity in the lower section, preventing water stagnation over time. The gap can be also used for pipes and installations.

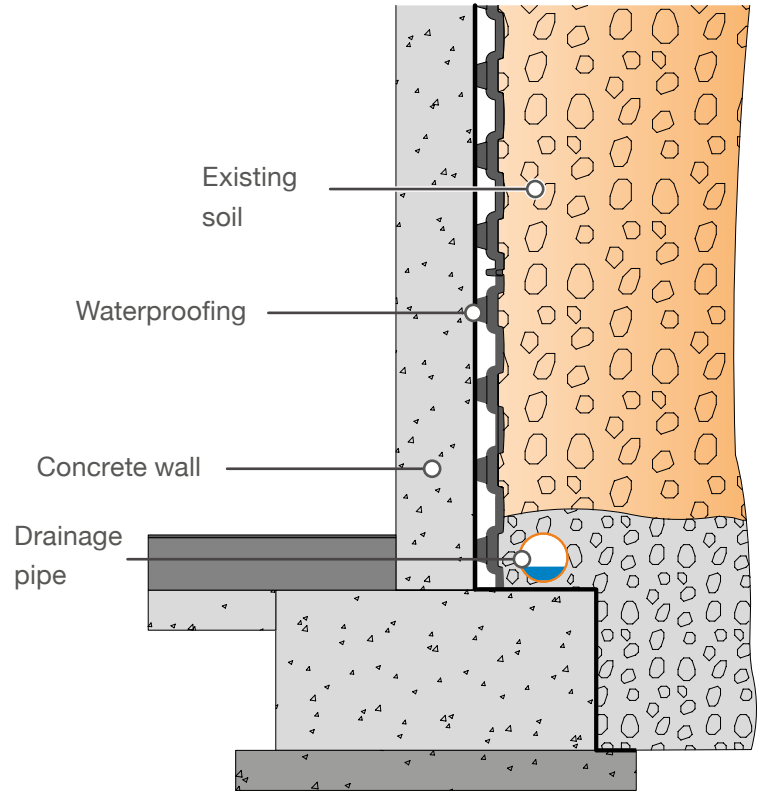
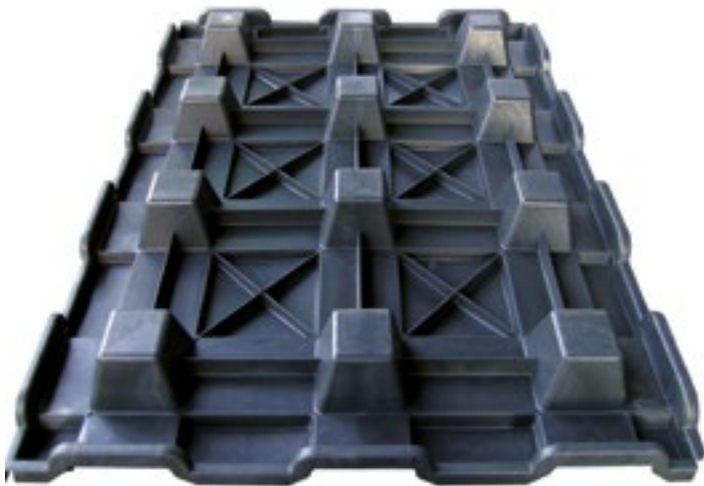

LOCKING SYSTEM

The innovative locking system facilitates the installation and guarantees the locking of the panels. The overlap at the edge of the panels prevents water from entering. DEFENDER elements don't require any kind of accessory.

INSTALLATION OF DEFENDER

DEFENDER is simple and cost-effective, easy to install and non-invasive as it does not require holes in the walls to secure the elements. Thanks to the many round support points, the load is distributed evenly over the sheath without risking to damage or pierce it.



① PREPARATION

Building of the wall in concrete and installation of the waterproofing (or bituminous) sheath. Set up a water collection pipe at the base of the wall.



② INSTALLATION

Installation of the panels from the right to the left. Use adhesives if compatibles with the sheath.



③ CUTTING

If necessary, DEFENDER formwork can be easily cut with angle grinders or circular saws to match edges and the top of the walls.



④ SEALING

Positioning of the sealings in plasticboard on the top and on the corners in order to protect the air gap from infiltrations. Create a superposition of at least 20 cm on the panel, securing it with screws.



⑤ FLEXIBILITY

The flexibility and the particular locking system of DEFENDER formwork allow an easy installation even on curved surfaces.



⑥ BACKFILL

After the installation, perform the backfill directly on the panels taking care not to damage them with the grab tool.

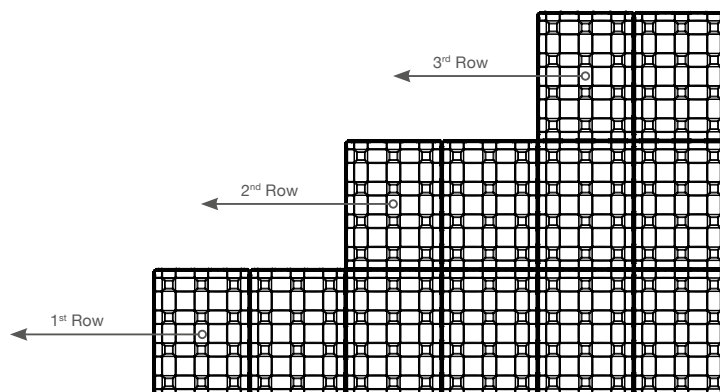
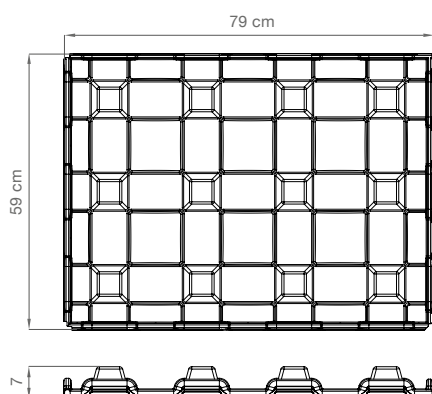

DEFENDER APPLICATIONS



THE PANEL

Installation of DEFENDER on already installed waterproofing sheaths.



THE CONNECTOR JOINTS

Positioning of the sealing elements made of corrugated plasticboard on the edges of the planimetry.



BACKFILL

Backfill with the material from the excavation.



SPECIAL APPLICATION WITH CONCRETE



Thanks to its strengthness, DEFENDER can be used as a formwork for concrete structures near the building. During outside interventions this product can be used to build walls foundations, sidewalks, stairs or ramps, boundary or retaining walls. DEFENDER does not deform and maintains the continuity of the air gap around the basement of the building, acting also as a joint.

TECHNICAL PRESCRIPTIONS

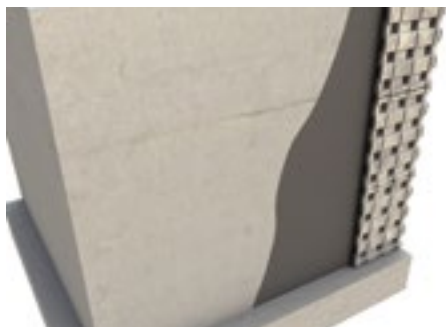

After the installation of the waterproofing, begins the installation of DEFENDER as the following image.



Fasten the top panel with a plug (preferably the chemical ones over the mechanical ones) near the curb of the slab.

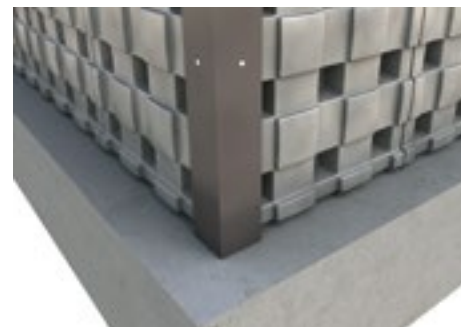

Apply a sheet of plasticboard near the corners and fasten it to DEFENDER with self-tapping screws (5 cm or less).

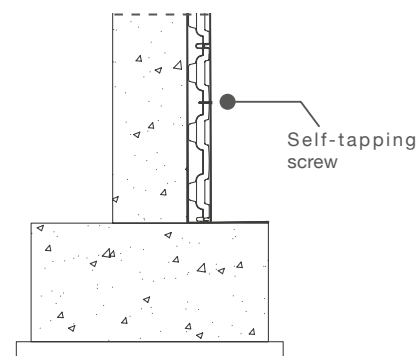
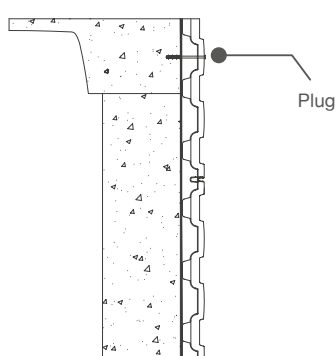
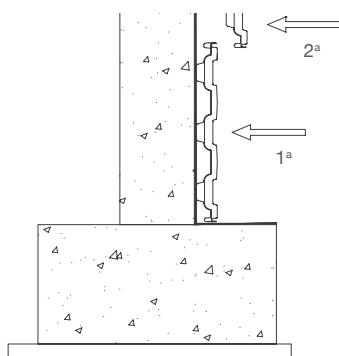

Place the corrugated plasticboard sheet on top of DEFENDER panels and fasten them with self-tapping screws.



Lay a drainage pipe along the perimeter of the building and close to the wall to discharge water into a drainage basin.

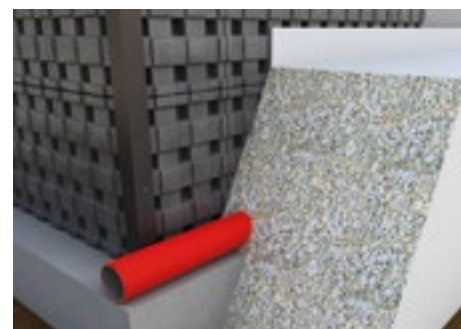

Before the backfill, pour gravel on the drainage pipe. Then lay the geotextile over it.

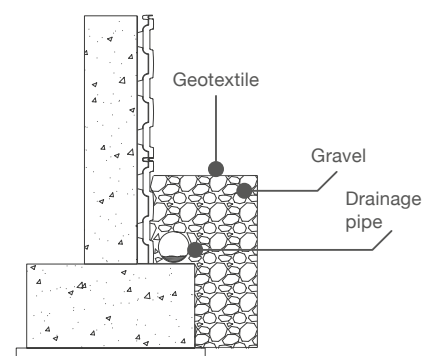
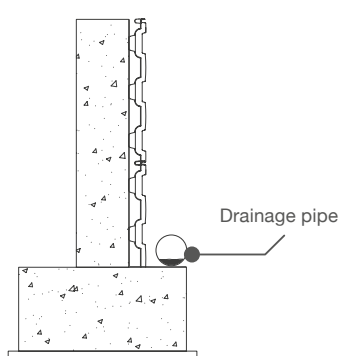
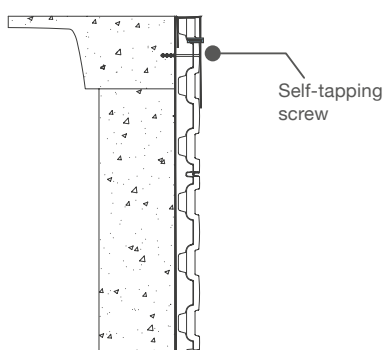



Geoplast S.p.A.

Via Martiri della Libertà, 6/8
35010 Grantorto (PD) - Italy

Tel +39 049 9490289
Fax +39 049 9494028

Geoplast@Geoplastglobal.com

GeoplastGlobal.com



rev. 07/2018

